

Moldings Stocked at L.P. Adams

Band Mold

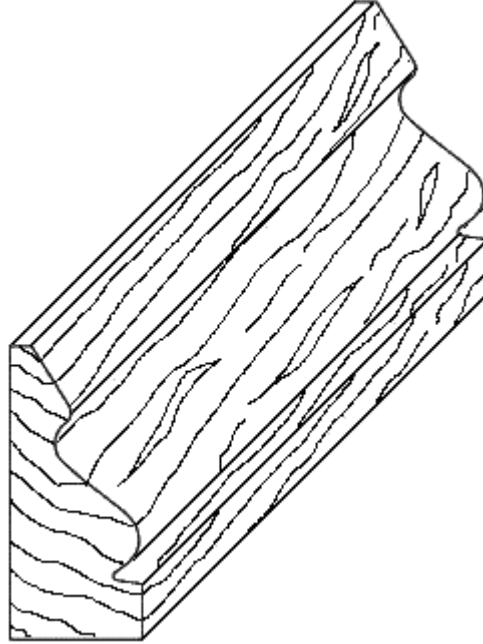

8463 11/16" x 1-1/2"

Base

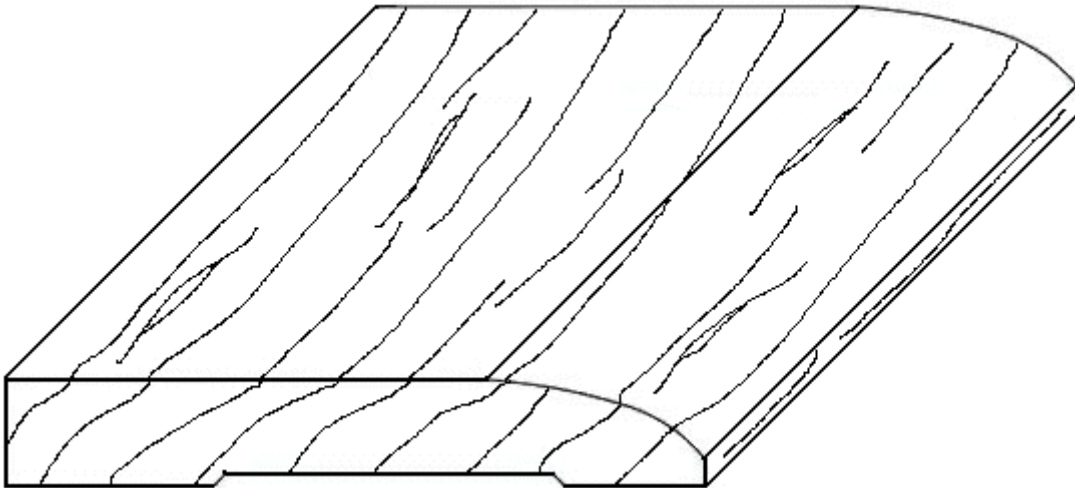

8720 9/16" x 3-1/2" Ranch

8721 9/16" x 4-1/2" Ranch

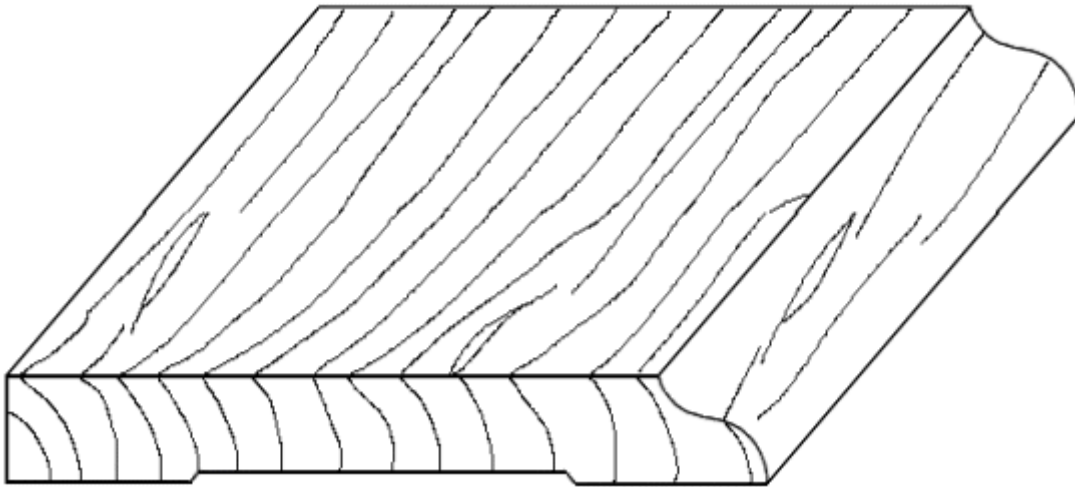

- # 8385A 9/16" x 3-1/2" Colonial
- # 8385B 9/16" x 4-1/2" Colonial
- # 8385A FJP 9/16" x 3-1/2" Colonial

FJP = Finger Jointed Primed

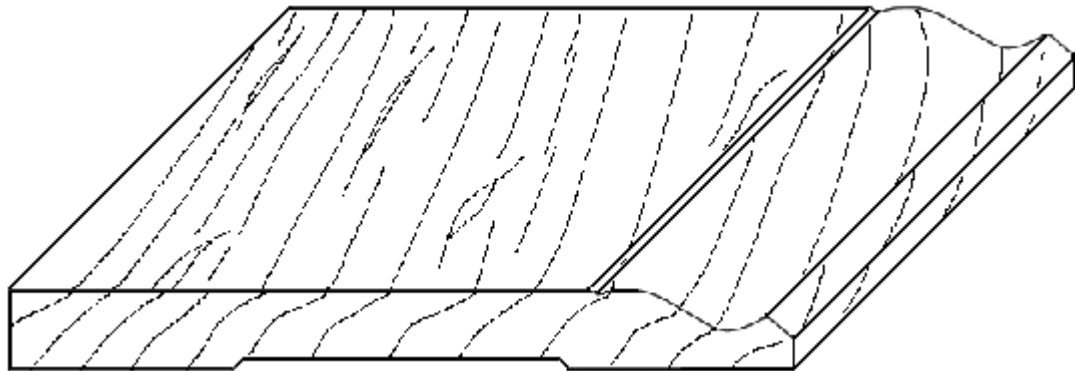

- # B400 FJP 9/16" x 5-1/4" Speed Base

FJP = Finger Jointed Primed

Base Cap

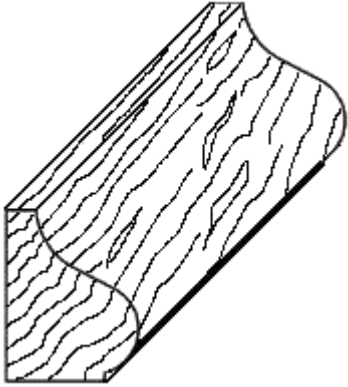

8042 Primed Finger Joint 5/8" x 3/4"

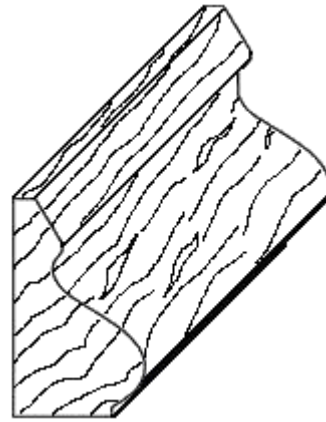

8453 Primed Finger Joint 11/16" x 1-1/8"

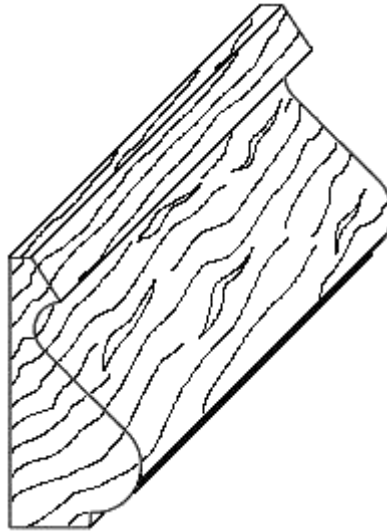

8455 Primed Finger Joint 11/16" x 1-3/8"

Baluster

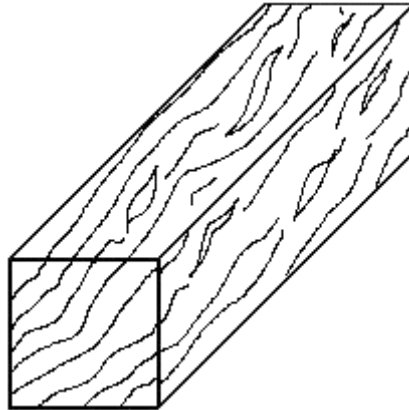

- # 8900 1-1/16" x 1-1/16"
- # 8901 1-5/16" x 1-5/16"
- # 8902 1-5/8" x 1-5/8"

Batten Strip

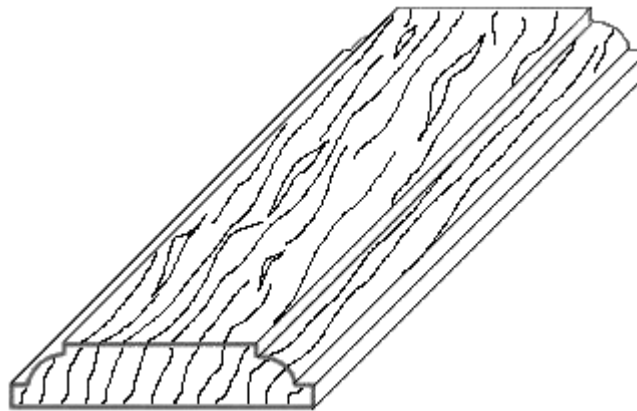

- # 8138 3/8" x 1-3/4"

Back Band

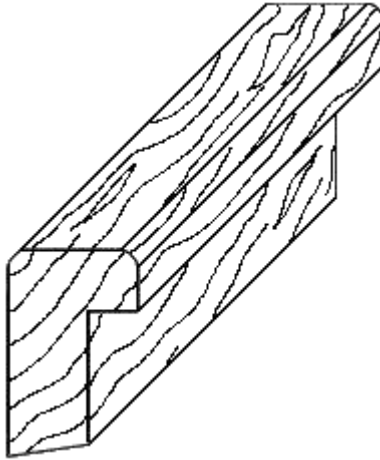

8313 11/16" x 1-1/16"

Bed Mold

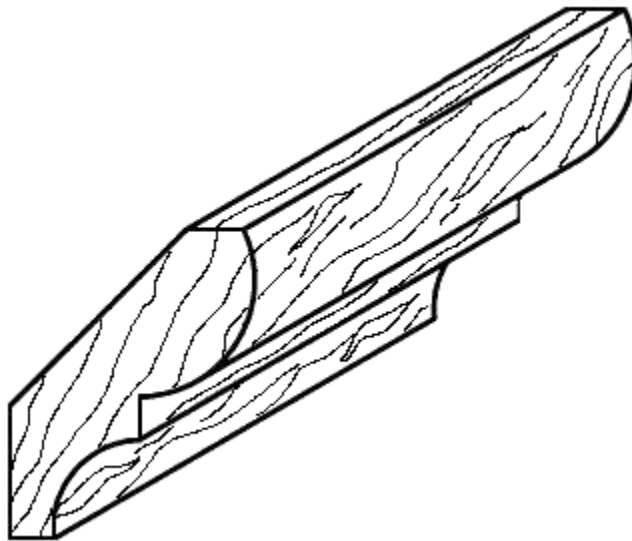

8016 9/16" x 1-3/4"

Casing

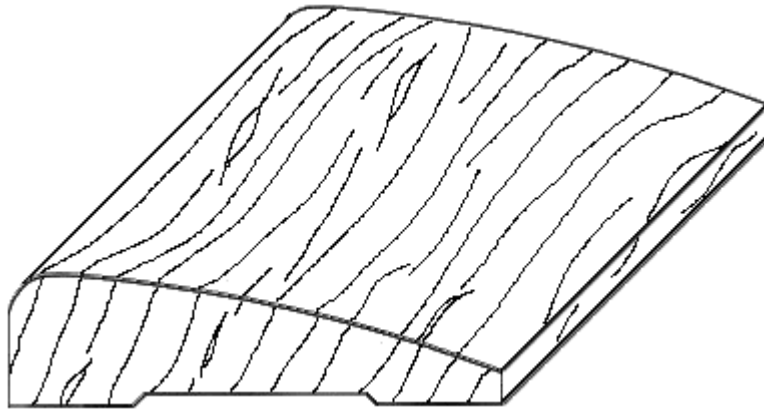

8730 2-1/2" Ranch

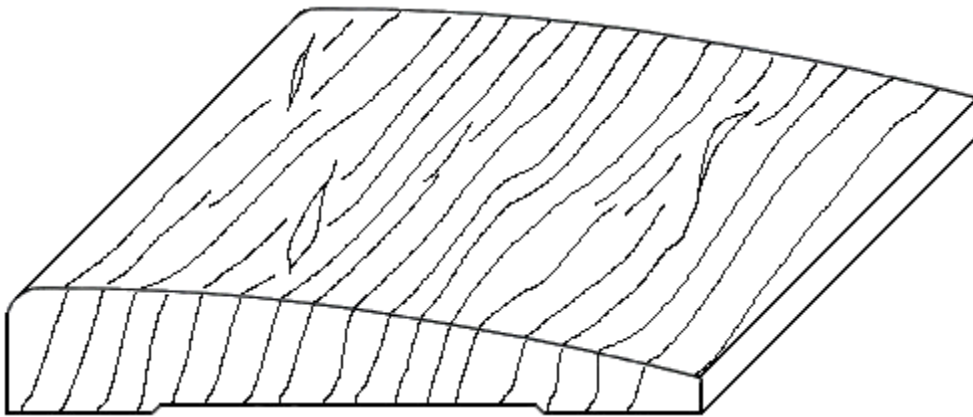

8731 3-1/2" Ranch

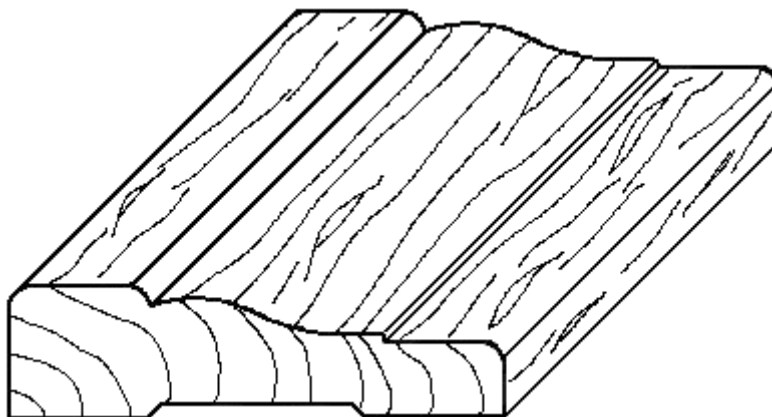

8710 2-1/2" Colonial
8710 FJP 2-1/2" Colonial
FJP = Finger Jointed Primed

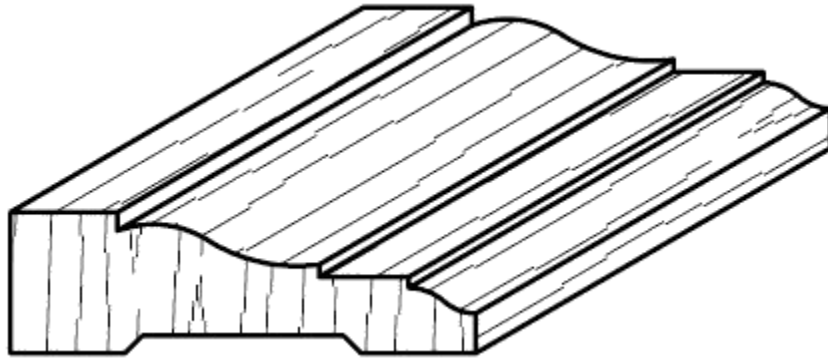

8753 2-1/2" Colonial

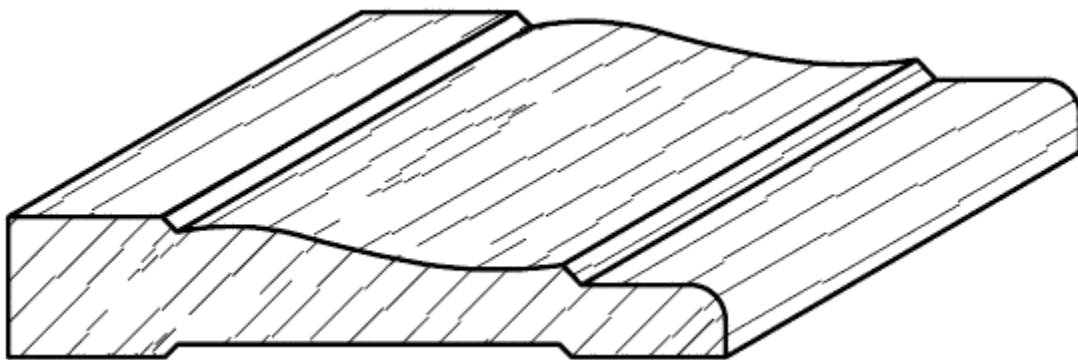

8754 3-1/2" Colonial
8754 FJP 3-1/2" Colonial
FJP = Finger Jointed Primed

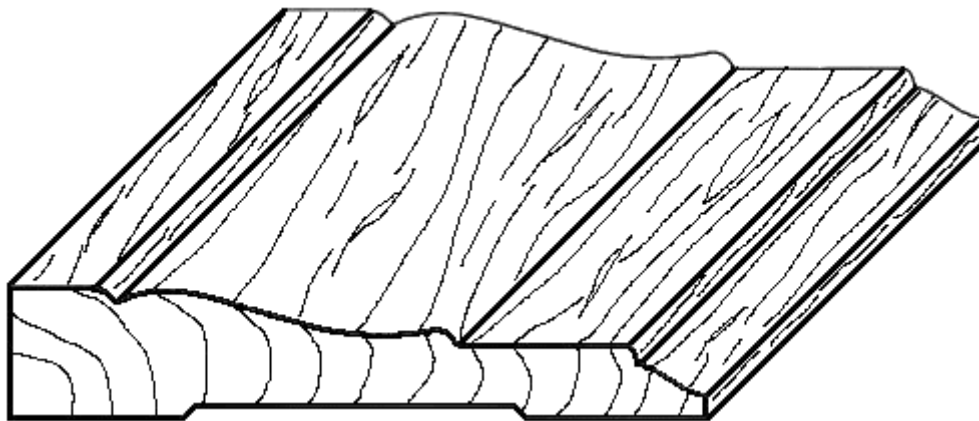

8753A 3-1/2" Colonial

-- Casing Continued --

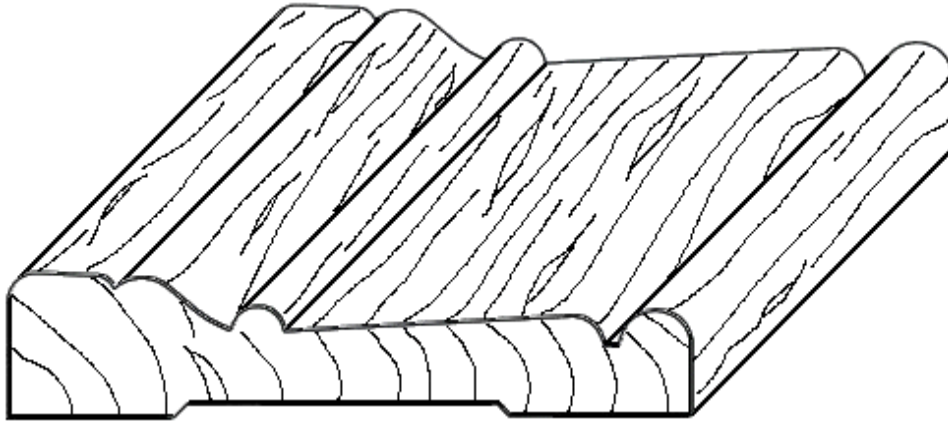

B225 FJP Stafford 11/16" x 3-1/2"

FJP = Finger Jointed Primed

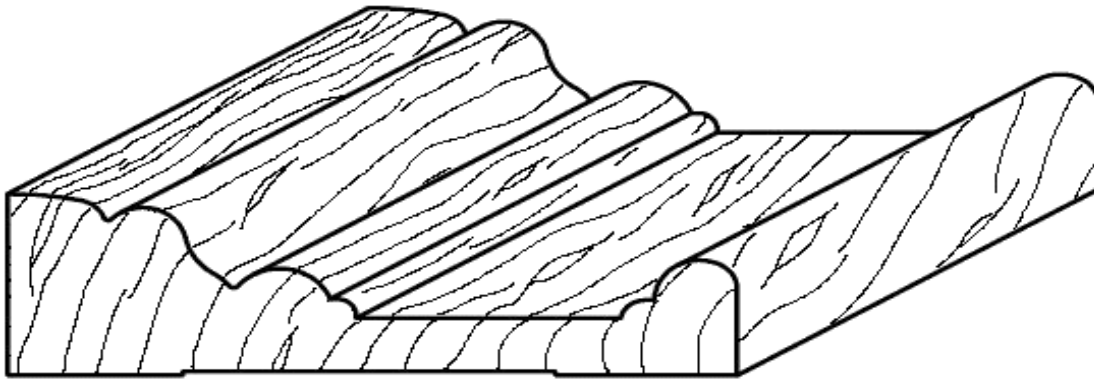

B200 FJP Windsor 1-1/16" x 3-1/2"

FJP = Finger Jointed Primed

Crown Mold

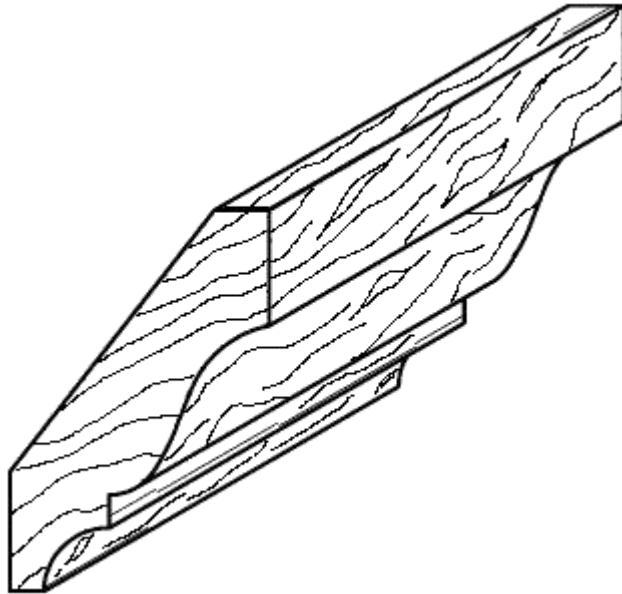

Crown Mold w/Cove

- # 8010 9/16" x 2-3/4"
- # 8010 FJP 9/16" x 2-3/4"
- # 8009 9/16" x 3-5/8"
- # 8009 FJP 9/16" x 3-5/8"
- # 8013 11/16" x 4-5/8"
- # 8013 FJP 11/16" x 4-5/8"
- # 8027 FJP 11/16" x 5-1/4"

FJP = Finger Jointed Primed

Chair Rail

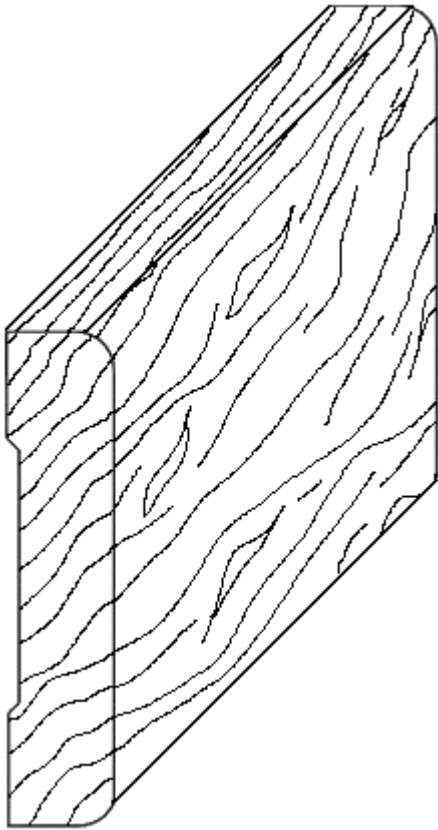

8627 9/16" x 2-1/2"

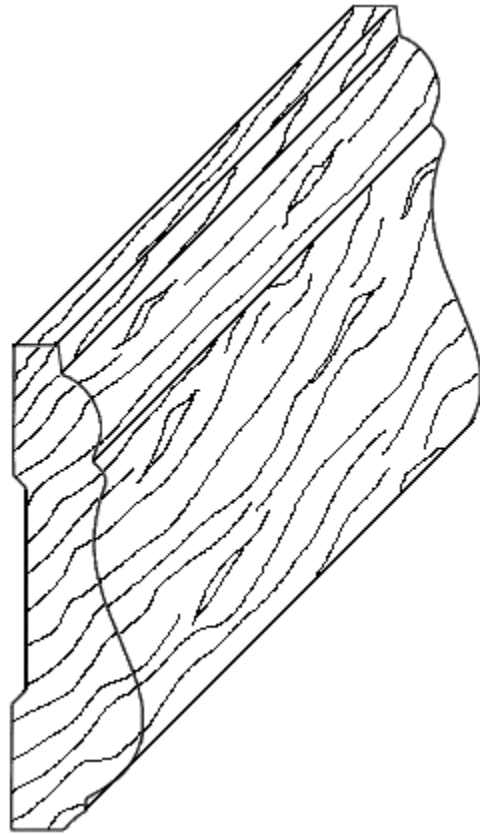

8630 Governor Francis 11/16" x 2-1/2"
8630 Governor Francis FJP 11/16" x 2-1/2"

FJP = Finger Jointed Primed

Cove Molding

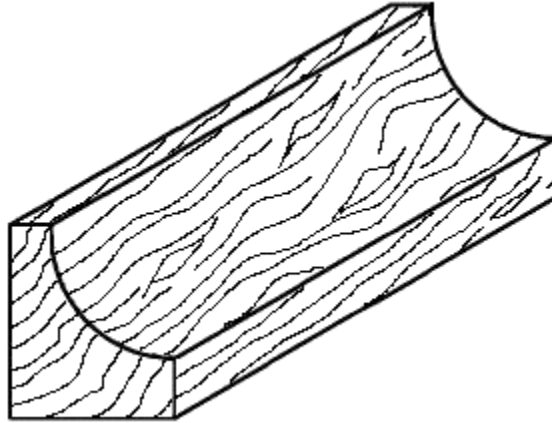

- # 8059B 1/2" x 1/2"
- # 8062 5/8" x 3/4"
- # 8062 FJP 5/8" x 3/4"

FJP = Finger Jointed Primed

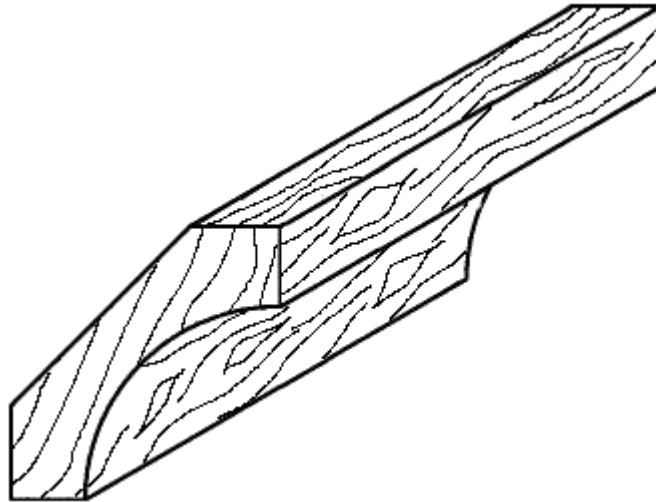

- # 8024 9/16" x 1-3/4"
- # 8025 11/16" x 2-1/4"

Closet Pole

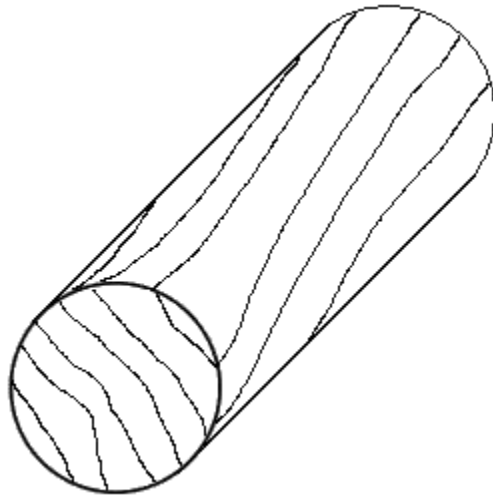

8912 1-5/16"
8913 1-1/2"

Corner Bead

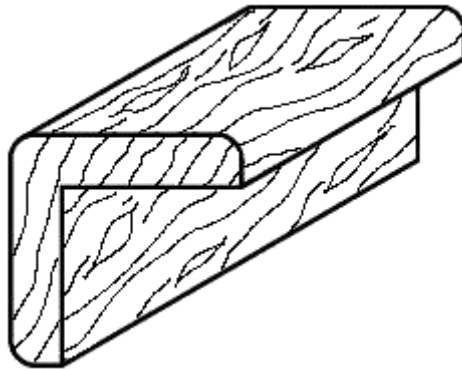

8240 3/4"
8200 1-1/16"
8238 1-5/16"

Drip Cap

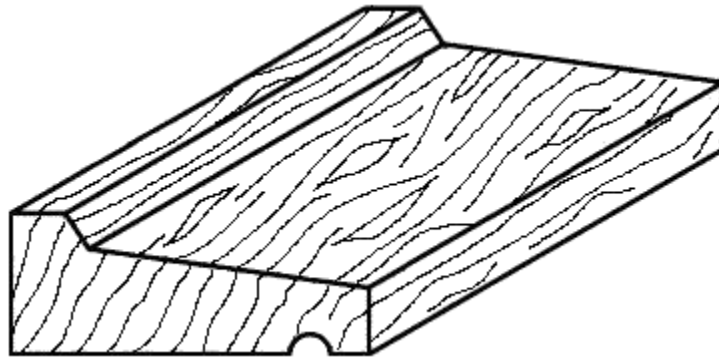

923 11/16" x 1-3/4"

923 FJP 11/16" x 1-3/4"

FJP = Finger Jointed Primed

Hand Rail

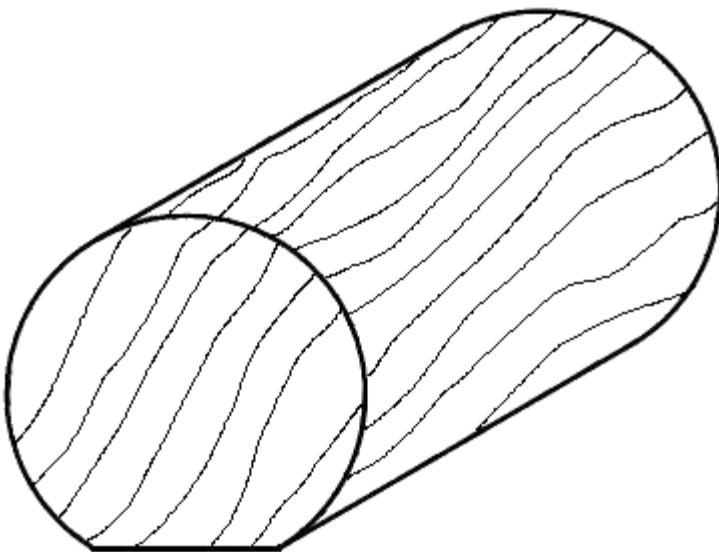

75 1-1/2" x 1-11/16"

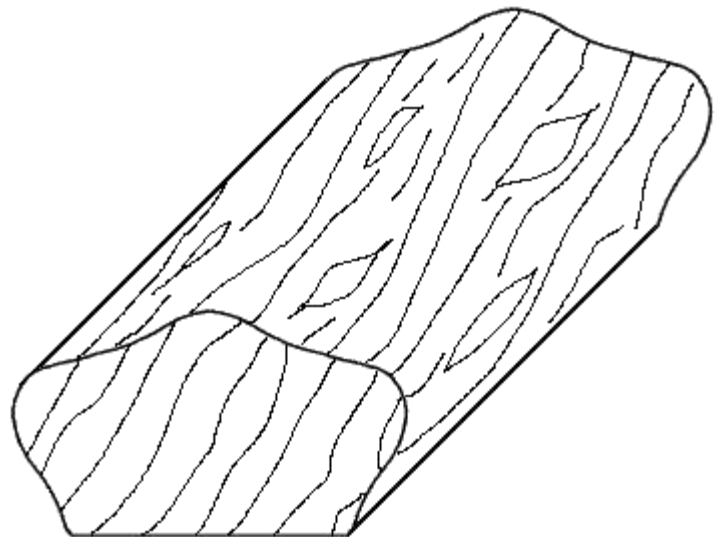

Clover 1-1/2" x 2-1/2"

Half Round

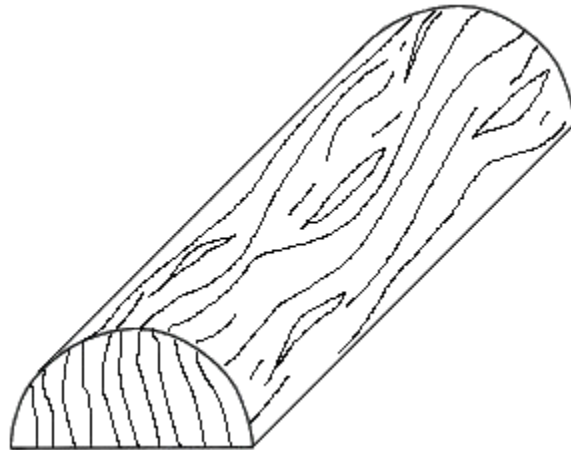

- # 8070 1/4" x 1/2"
- # 8077 3/8" x 11/16"
- # 8079 5/8" x 1-1/4"

Lattice

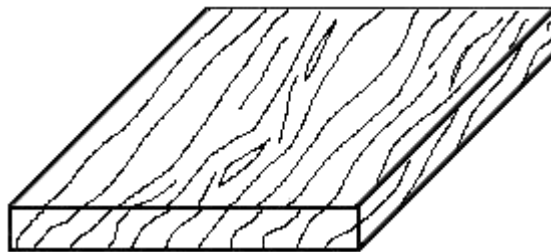

- # 8280 1/4" x 1-1/8"
- # 8281 1/4" x 1-5/16"
- # 8282 1/4" x 1-3/4"
- # 8228 3/8" x 2-1/4"

Picture Mold

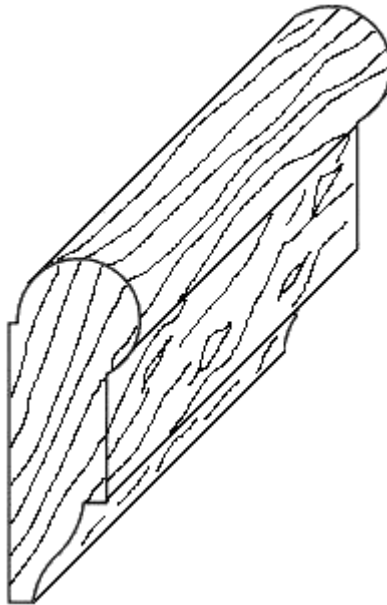

8263 11/16" x 1-3/4"

Quarter Round

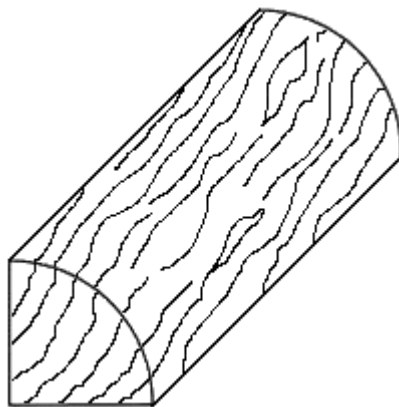

8057 1/4" x 1/4"

8063 1/2" x 1/2"

8065 3/4" x 3/4"

-- Quarter Round Continued --

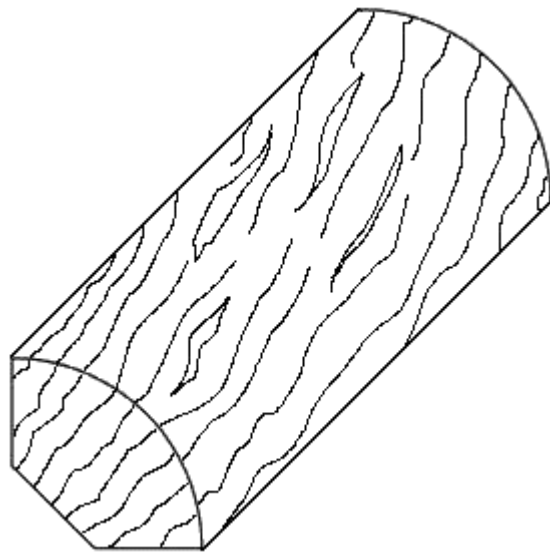

8067 11/16" x 1-3/8"

Screen Stock & Shelf Edge

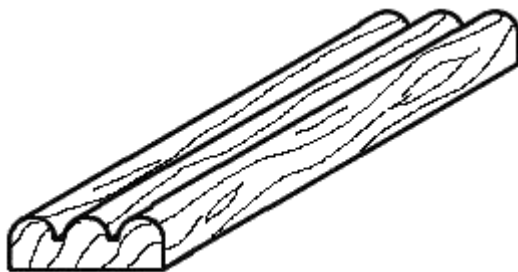

8611 1/4" x 3/4"

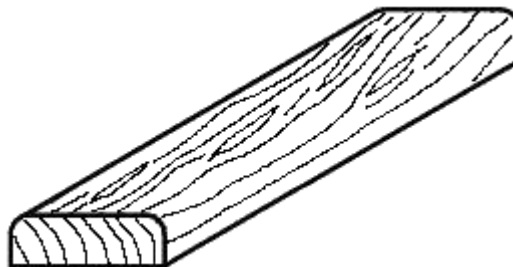

8610 1/4" x 3/4"

Staff Bead

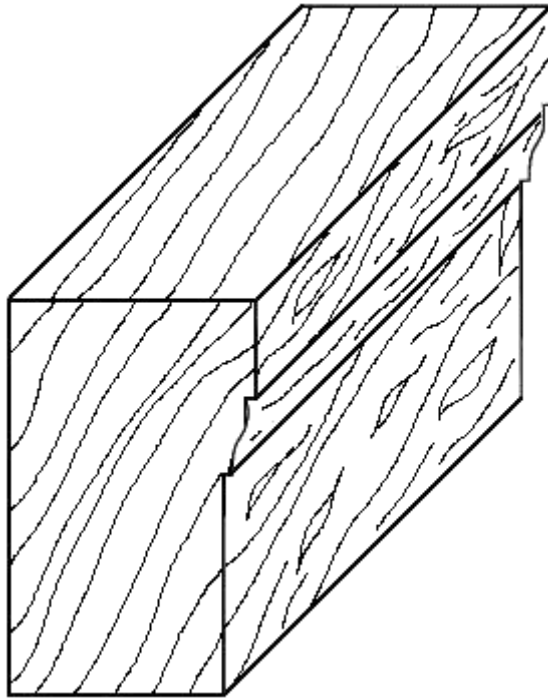

908 1-1/4" x 2"

908 FJP 1-1/4" x 2"

FJP = Finger Jointed Primed

Base Shoe

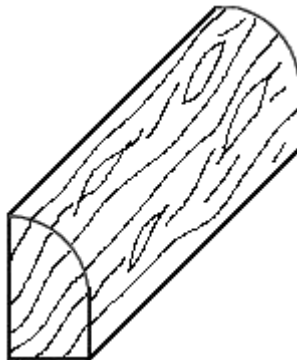

8422 7/16" x 3/4"

WM126 Primed 11/16" x 3/4"

Stops

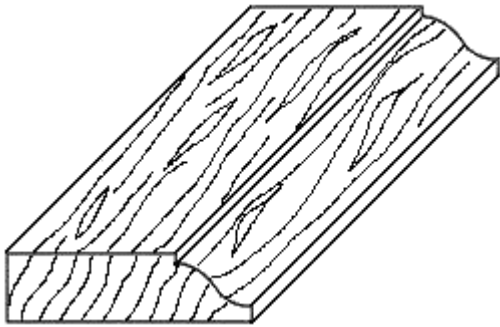

8098 3/8" x 1-1/4" Colonial

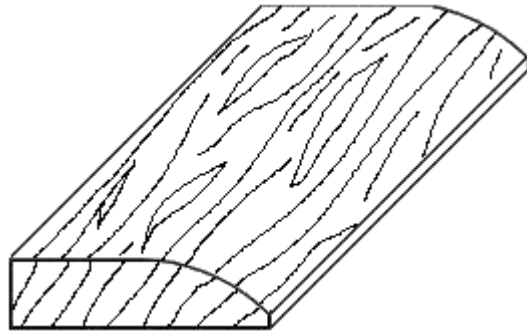

1287 3/8" x 1-1/4" Ranch

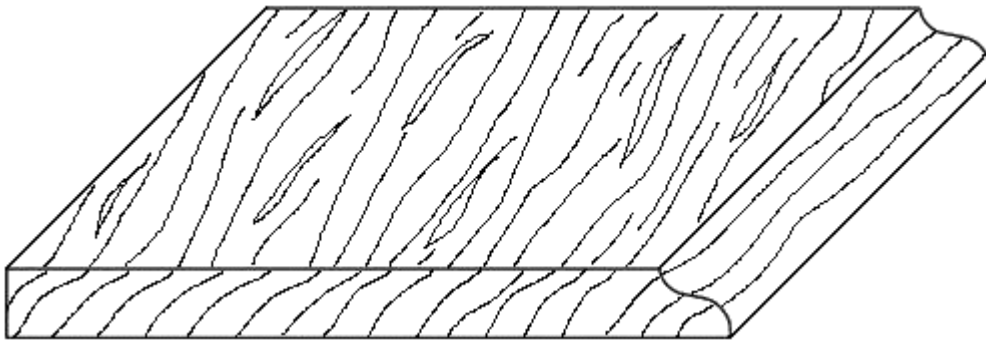

- # 8093A 3/8" x 2-1/2" Colonial
- # M358CS 3/8" x 3-5/8" Colonial
- # 8093B 7/16" x 4-1/4" Colonial

Stool Moldings

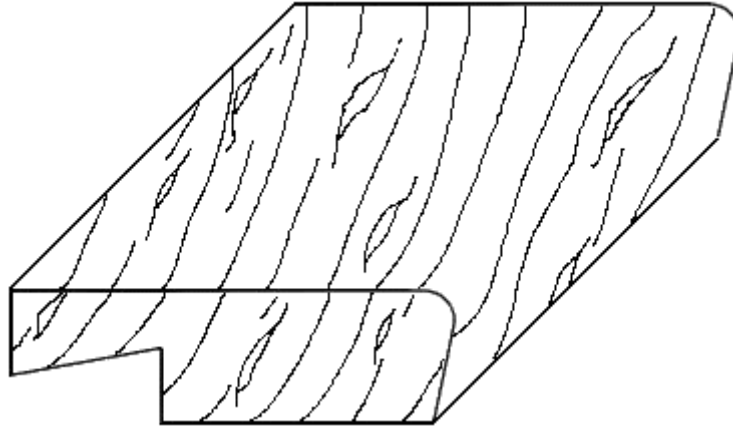

11/16" x 2-1/2" Stool

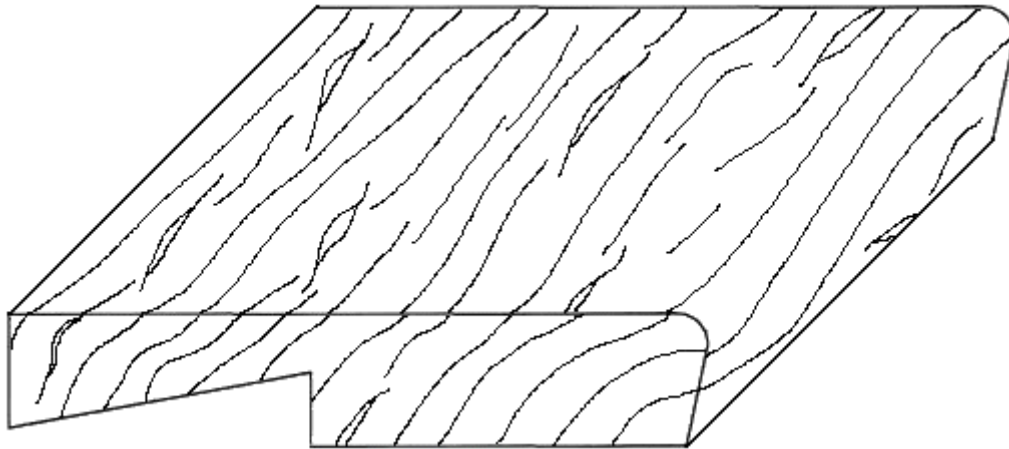

11/16" x 3-1/2" Stool

Oak Nosing

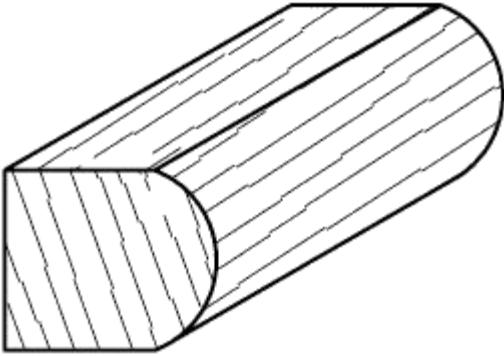

5/4" x 1-1/2" Oak Nosing

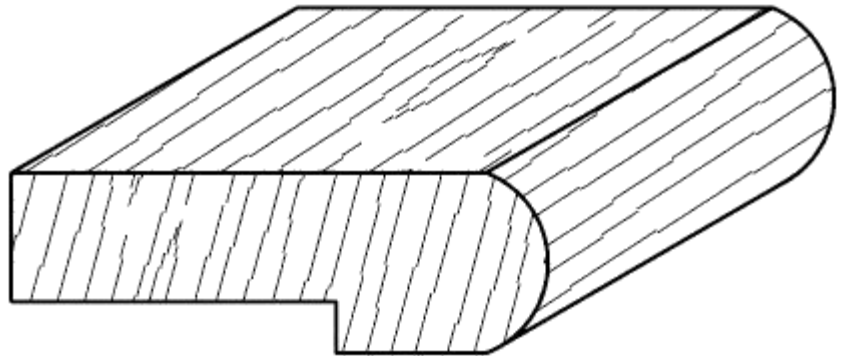

5/4" x 3-1/2" Oak Nosing

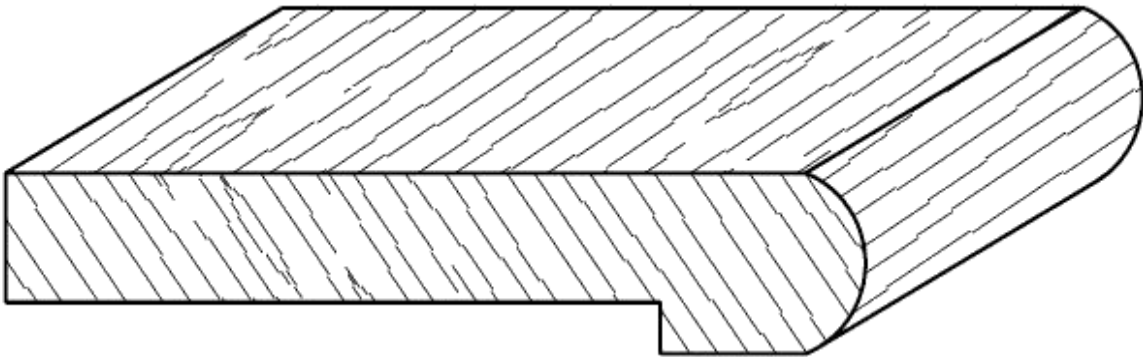

5/4" x 5-1/4" Oak Nosing

Clear Pine

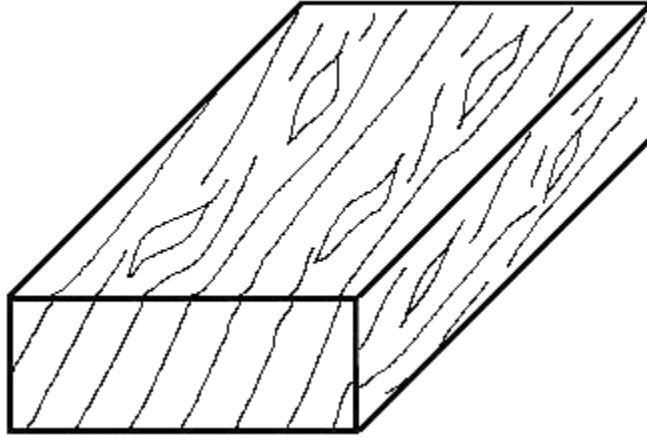

8614 11/16" x 1-3/4"

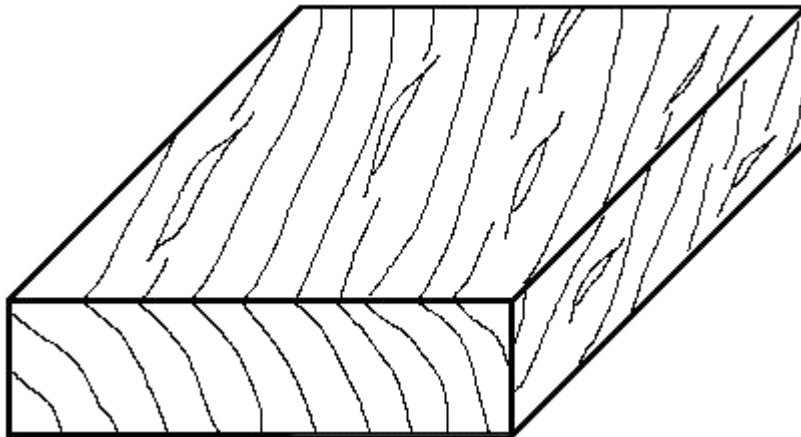

8615 11/16" x 2-3/4"

Parting Bead

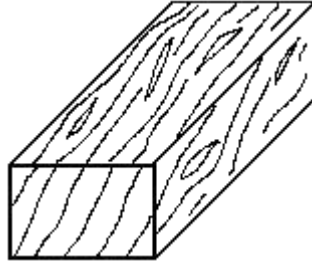

8432 1/2" x 3/4"

Plywood Cap

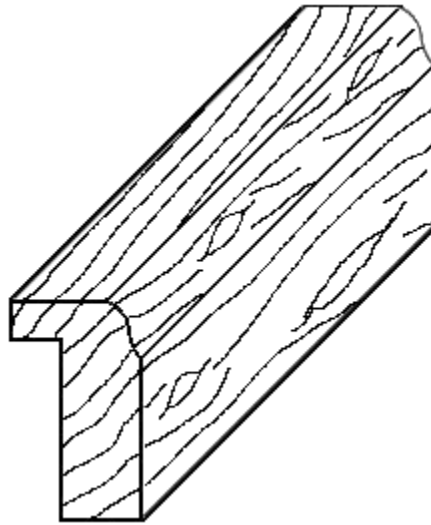

B670 11/16" x 1-1/8"

Chamfer Strip

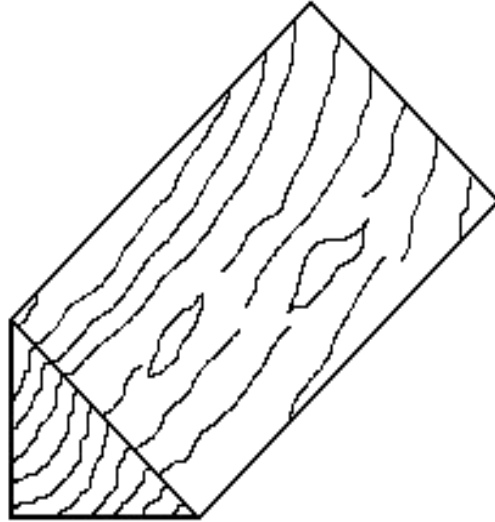

B995 3/4" x 3/4"